

StarMax[®]

ELECTRIC GRIDDLES

MODEL

515TGF, 524TGF,
536TGF, 536TGF-PE, 548TGF

CHROME-MAX MODEL

524CHSF, 536CHSF, 548CHSF

Installation and Operation Instructions

2M-Z16009 Rev. E 06/2019



536TGF



SAFETY SYMBOL



These symbols are intended to alert the user to the presence of important operating and maintenance instructions in the manual accompanying the appliance.

RETAIN THIS MANUAL FOR FUTURE REFERENCE NOTICE

Using any part other than genuine Star factory supplied parts relieves the manufacturer of all liability.

Star reserves the right to change specifications and product design without notice. Such revisions do not entitle the buyer to corresponding changes, improvements, additions or replacements for previously purchased equipment.

Due to periodic changes in designs, methods, procedures, policies and regulations, the specifications contained in this sheet are subject to change without notice. While Star International Holdings Inc., Company exercises good faith efforts to provide information that is accurate, we are not responsible for errors or omissions in information provided or conclusions reached as a result of using the specifications. By using the information provided, the user assumes all risks in connection with such use.

MAINTENANCE AND REPAIRS

Contact your local authorized service agent for service or required maintenance.

Please record the model number, serial number, voltage and purchase date in the area below and have it ready when you call to ensure a faster service.

Model No. _____
Serial No. _____
Voltage _____
Purchase Date _____

Authorized Service Agent Listing

Reference the listing provided with the unit

or

for an updated listing go to:

Website: www.star-mfg.com
E-mail: customerservice@star-mfg.com

Service Help Desk

Business Hours: 8:00 am to 4:30 p.m. Central Standard Time

Telephone: (800) 264-7827

Fax: (314) 781-2714

E-mail: customerservice@star-mfg.com

Website: www.star-mfg.com

Mailing Address: Star Manufacturing International Inc.
265 Hobson Street
Smithville, TN 37166
U.S.A



GENERAL INFORMATION

This equipment is designed and sold for commercial use only by personnel trained and experienced in its operation and is not sold for consumer use in and around the home nor for use directly by the general public in food service locations.

Before using your new equipment, read and understand all the instructions & labels associated with the unit prior to putting it into operation. Make sure all people associated with its use understand the units operation & safety before they use the unit.

All shipping containers should be checked for freight damage both visible and concealed. This unit has been tested and carefully packaged to insure delivery of your unit in perfect condition. If equipment is received in damaged condition, either apparent or concealed, a claim must be made with the delivering carrier.

Concealed damage or loss - if damage or loss is not apparent until after equipment is unpacked, a request for inspection of concealed damage must be made with carrier within 15 days. Be certain to retain all contents plus external and internal packaging materials for inspection. The carrier will make an inspection and will supply necessary claim forms.

INSTALLATION

The griddles are equipped for the voltage indicated on the nameplate mounted under the bullnose on the front panel. They will operate on alternating current (AC) only.

DO NOT CONNECT TO DIRECT CURRENT (DC).

The installation of the electric griddle should conform to the:

NATIONAL ELECTRIC CODE AND ALL LOCAL ELECTRIC CODES AND ORDINANCES AND THE LOCAL ELECTRIC COMPANY RULES AND REGULATIONS

For your protection we recommend that a qualified electrician install this griddle. He should be familiar with electrical installations and all electric codes. Proper connections and power supply are essential for efficient performance. The external wiring should be in conduit or an approved type of flexible cable suitable for operation at the temperature indicated on the wiring diagram, and of a proper size to carry the load. The supply circuit should be properly fused and equipped with a means of disconnecting, as required by local electrical code. **THE BODY OF THE GRIDDLE SHOULD BE GROUNDED (DO NOT GROUND TO A GAS SUPPLY LINE).**

GENERAL OPERATING PROCEDURES

The Chrome-Max and Star-Max series electric griddles may be wired for operation in the field for either 1-phase or 3-phase power supplies by making line connections at the junction box(es) located at the rear of the unit. Two junction boxes are provided on the 548TGF for making line connections. These may be connected in parallel to one 16KW 3-phase line or on two separate 8KW lines.

CONNECTING POWER SUPPLY

Detach cover on junction box at rear of unit. There are pigtail leads for the supply connection in the junction box.

LOCATING AND LEVELING THE UNIT

Do not install the unit closer than 1-inch from a side wall and/or closer than 1-inch from a rear wall. Level unit by adjusting the (4) feet which have an adjustment of 1-3/4" (43.75mm) for accurate leveling and perfect line-up with other Star-Max series units. After the griddle is in its final position, adjust the legs to create 1/8 inch slant from back to front on the griddle plate. This will allow grease to run into the grease gutter and provide the proper air flow.

EXHAUST CANOPY

Griddles inherently create a good deal of heat and smoke and should be installed under an efficient exhaust hood with flame proof filters. A vertical distance of not less than 48" shall be provided between the top of the appliance and filters or any other combustible material. Exhaust installation must conform to local codes.

AIR SUPPLY: Provisions for adequate air supply must be provided.



2M-Z16009 Star-Max Electric Griddle

SEASONING THE GRIDDLE HEATING SURFACE (NON CHROMIUM SURFACE)

Clean the griddle surface thoroughly. After the griddle has been thoroughly cleaned, it should be seasoned to prevent food from sticking. Before using and after each thorough scouring, season the griddle heating surface in the following manner.

1. Turn temperature control dials to 350°F (177°C).
2. Using a clean cloth, not a spatula, spread a thin film of cooking oil over the griddle cooking surface. This film should remain on the hot griddle surface for half an hour.
3. Remove the excess oil and wipe clean.
4. Apply another film of cooking oil over the hot cooking area for another half hour and again remove excess oil and wipe clean. The griddle surface should now be ready for use.

Even with careful seasoning, food may, to some extent, stick to the griddle cooking surface until the griddle plate is broken in.

TEMPERATURE CONTROL

The temperature controls are combination “ON/OFF” switches and thermostats. Turning the dial knob automatically maintains the selected heat range.

The Star-Max/Chrome-Max electric griddle line has one thermostat for every 12” (30cm) section of griddle that operates independently of one another. Each thermostat controls the section of the griddle above it and may be set at different temperatures as desired.

COOKING

Set the thermostat dial knob at the temperature desired. After a short pre-heating period, the thermostat will automatically maintain the selected temperature.

IDLING

During idle periods, to save on operating costs, lower the temperature setting of the thermostat to about 250°F (121°C). It is not necessary to maintain cooking temperature during idle periods, as the griddle can quickly be reheated to the desired temperature.

SIGNAL LIGHTS

Each thermostat has its own signal light which indicates when the unit’s control knob is not in the off position.

GRIDDLE CARE (NON-CHROMIUM SURFACES)

It takes very little time and effort to keep the griddle attractive and performing at top efficiency. If grease is permitted to accumulate, it will form a gummy cake and then carbonize into a hard substance which is extremely difficult to remove. To prevent this condition, the following suggestions for cleanliness should be followed:

1. After each use, scrape the griddle with a scraper or flexible spatula to remove excess grease and food. A waste drawer is provided for the scrapings. If there is an accumulation of burned on grease and food, the griddle should be thoroughly scoured and reseasoned. Use pumice or griddle stone while the griddle is warm. Do not use steel wool because of the danger of steel slivers getting into the food.
2. Daily, use a clean cloth and a good non-abrasive cleaner to clean the stainless steel body of the griddle. Wipe the polished front with a soft cloth.
3. At least once a day, remove the waste drawer and wash in the same way as an ordinary cooking utensil. The drawers are removed by pulling forward until they are released from their track.

GRIDDLE CARE (CHROMIUM SURFACES)

It takes very little time and effort to keep this Industrial Chromium griddle surface sparkling clean and performing at top efficiency. **DO NOT** allow grease to accumulate as it will carbonize and become difficult to remove. To prevent this condition the following cleaning suggestions should be followed:

1. Remove excess grease and food regularly with a 4" (100mm) wide Razor Sharp type scraper and wipe surface with a damp cloth if desired.
2. Following the scraping, for end of the day cleaning, a damp cloth and a non-silicated, non-abrasive, non-chlorinated cleaner such as Bon-Ami may be used to wipe surface clean, followed by wiping with a clean wet cloth.
3. Follow steps 2 and 3 from Griddle Care (Non-Chromium Surfaces) above.



CAUTION

1. **Never** use pumice, griddle stones, or abrasives on a chromium surface.
2. **Never** strike a chromium griddle surface with a sharp instrument or spatula edge.
3. **Never** use steel wool.
4. **Never** use commercial liquid grill cleaner on the griddle surface.
5. **Abusing** surface voids the warranty.

MAINTENANCE AND REPAIRS

Contact the factory, a service representative, or a local service company for service or required maintenance.

CHROME-MAX GRIDDLE SURFACE LIMITED WARRANTY EXCLUSIONS

Your Chrome-Max griddle has been designed to give you many years of cooking reliability and requires minimum maintenance to keep the chrome surface in its original condition. All Chrome-Max griddle surfaces are warranted for a period of 5 years against manufacturing defects to the original owner from the date of installation. This limited warranty is void if it is determined by Star Manufacturing International Incorporated or one of its authorized representatives that the chrome surface has been misused or abused or subjected to the following situations:

1. Improperly installed.
2. Incorrect voltage applied to electric Chrome-Max units allowing the surface to overheat and discolor.
3. The misuse of any instrument or tool which scratches or makes indentations in the surface which could cause the surface to peel, flake, or chip off.
4. The use of any chemical or abrasive cleaning solution, griddle brick, stone, screen or other cleaning products which could damage and affect the performance of the chrome surface.
5. The neglect of daily routine maintenance to the chromium surface.

LIMITED EQUIPMENT WARRANTY

Star Manufacturing [as well as its subsidiaries, Toastmaster and Holman] warranties new products to be free from defects in material and/or workmanship for a period of one [1] year from the date of original installation, except as noted below. Defects that occur as a result of normal use, within the time period and limitations defined in this warranty, will at Star’s discretion have the parts replaced or repaired by Star or a Star-authorized service agency.

THIS WARRANTY IS SUBJECT TO ALL LISTED CONDITIONS.

Repairs performed under this warranty are to be performed by a Star authorized service agency. Star will not be responsible for charges incurred or service performed by non-authorized repair agencies. In all cases, the nearest Star-authorized service agency must be used. Star will be responsible for normal labor charges incurred in the repair or replacement of a warranted product within 50 miles (80.5 km) of an authorized service agency. Time and expense charges for anything beyond that distance will be the responsibility of the owner. All labor will need to be performed during regular service hours. Any overtime premium will be charged to the owner. For all shipments outside the U.S.A. and Canada, please see the International Warranty for specific details. It is the responsibility of the owner to inspect and report any shipping damage claims, hidden or otherwise, promptly following delivery. No mileage or travel charges will be honored on any equipment that is deemed portable. In general, equipment with a cord and plug weighing less than 50 lb. (22.7 kg) is considered portable and should be taken or shipped to the closest authorized service agency, transportation prepaid.

PORTABLE EQUIPMENT EXAMPLES

- 514LL fryer
- 15MC and 18MCP hot food merchandisers
- QCS1, QCS2, and RCS2 toasters
- 16PD-A pretzel merchandisers
- Condiment dispensers except HPD- and SPD-series models
- All pop-up toasters
- All pastry display cabinets
- All heat lamps
- J4R popcorn machine
- 12NCPW and 15NCPW nacho merchandisers
- Nacho cheese warmers except 11WLA-series models
- Specialty food warmers except 13OR, 11RW, and 11WSA models
- All butter dispensers
- All nacho chip merchandisers
- All accessories

CONTACT

Should you require any assistance regarding the operation or maintenance of any Star equipment; write, phone, fax or email our service department. In all correspondence mention the model number and serial number of your unit, as well as the voltage or type of gas you are using. Business hours are 8:00 a.m. to 4:30 p.m. Central Standard Time (CST)
 Telephone: (800)-264-7827
 Fax: (314)-781-2714
 Email: Customerservice@star-mfg.com
www.star-mfg.com

WARRANTY EXCLUSIONS

THE FOLLOWING WILL NOT BE COVERED UNDER WARRANTY.

- Any product which has not been used, cleaned, maintained, or installed in accordance with the directions published in the appropriate installation sheet and/ or owner’s manual as well as national and local codes, including incorrect gas, electrical, or water connection. Star is not liable for any unit which has been mishandled, abused, misapplied, subjected to chlorides, harsh chemicals, or caustic cleaners, damaged from exposure to hard water, modified by unauthorized personnel, damaged by flood, fire, or other acts of nature [or God], or which have an altered or missing serial number.
- Installation, labor, and job checkouts, calibration of heat controls, air and gas burner/bypass/pilot adjustments, gas or electrical system checks, voltage and phase conversions, cleaning of equipment, or seasoning of griddle surface.
- Replacement of fuses or resetting of circuit breakers, safety controls, or reset buttons.
- Replacement of broken or damaged glass components, quartz heating elements, and light bulbs.
- Labor charges for all removable parts in gas charbroilers and hotplates, including but not limited to burners, grates, and radiants.
- Any labor charges incurred by delays, waiting time, or operating restrictions that hinder a service technician’s ability to perform service.
- Replacement of items subject to normal wear or items that can easily be replaced during a daily cleaning routine, such as but not limited to knobs, bulbs, fuses, quartz heating elements, baskets, racks, and grease drawers.
- Components that should be replaced when damaged or worn, but have been field-repaired instead [eg. field-welded fry pots]
- Any loss of business or profits.

PRODUCTS	PARTS	LABOR
Star-Ultra Max® fryers, griddles, charbroilers, and hotplates	2 years	2 years
Star-Max® fryers, griddles, charbroilers, and hotplates	2 years	2 years
Jetstar® popcorn poppers	2 years	2 years
Staltek™ roller grill coatings	5 years	
Cast iron grates, burners; and burner shields	180 days	
Star, Toastmaster, or Holman parts sold to repair equipment	90 days	
Service First	1 year	

2M-Z16009 Star-Max Electric Griddle

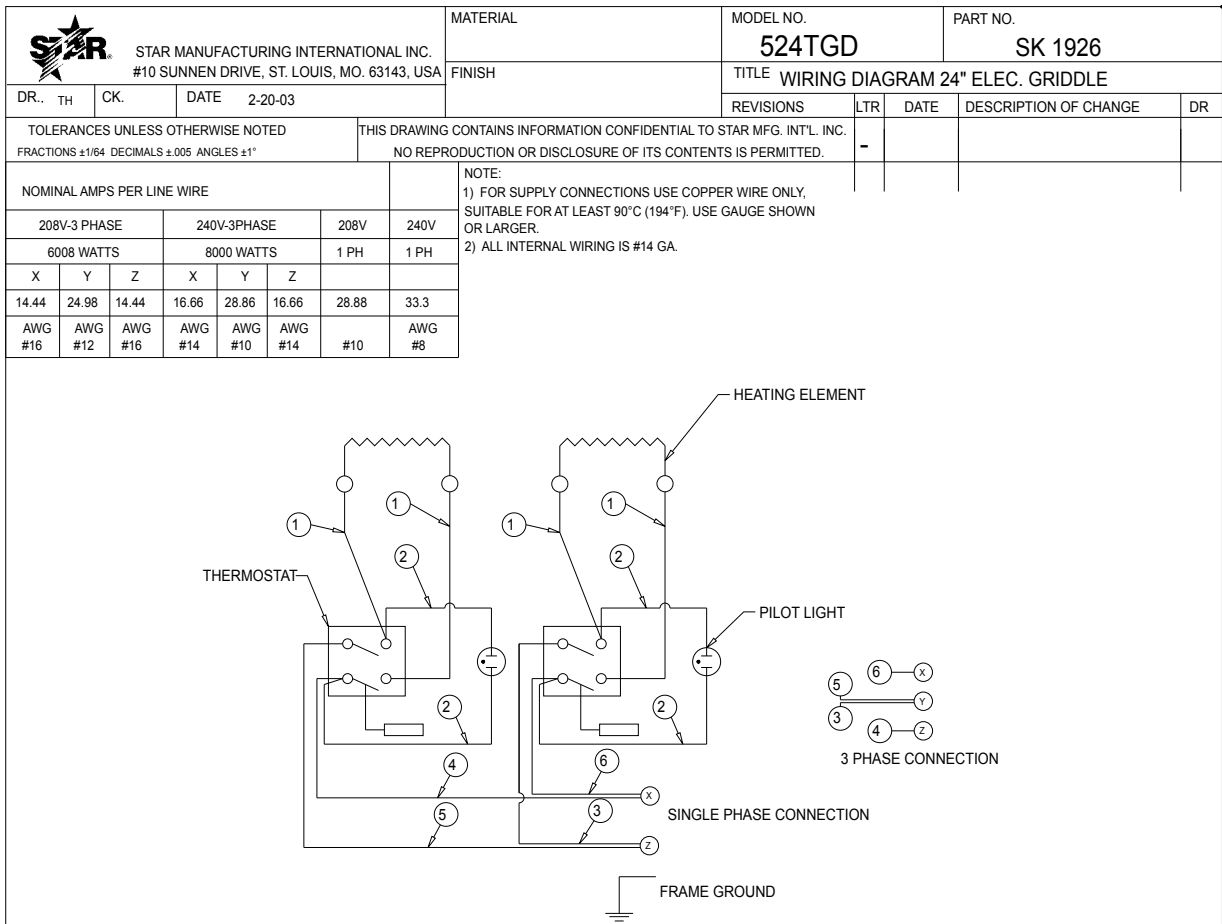
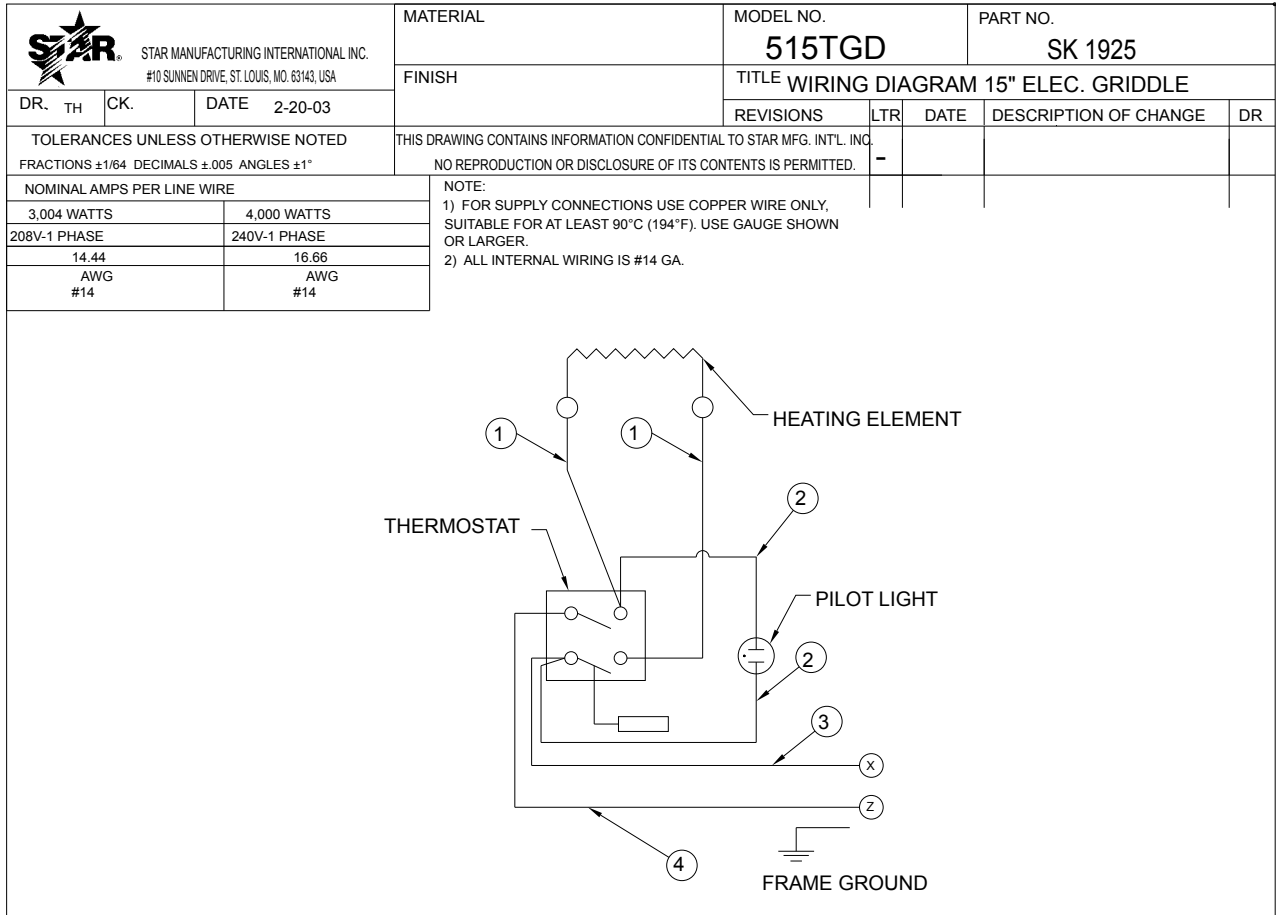

2M-Z16009 Star-Max Electric Griddle

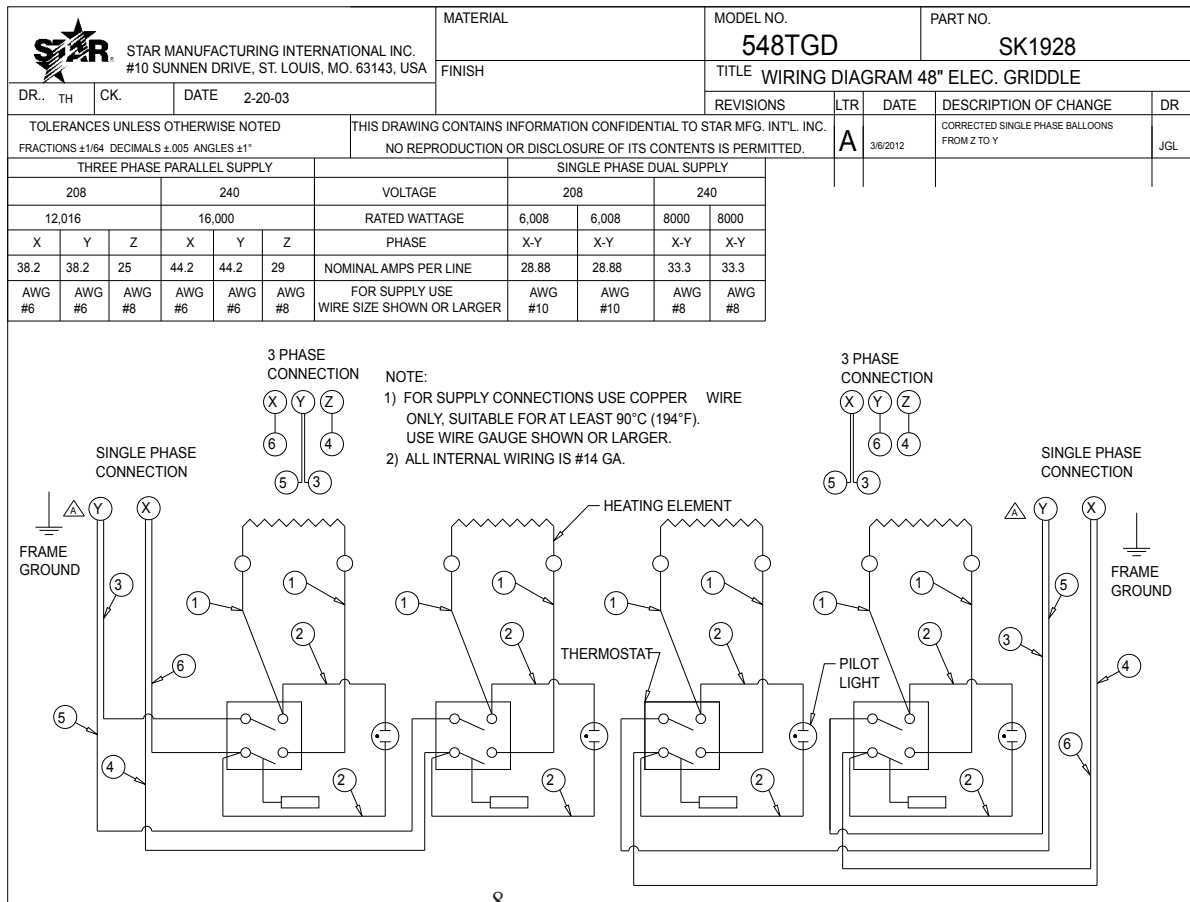
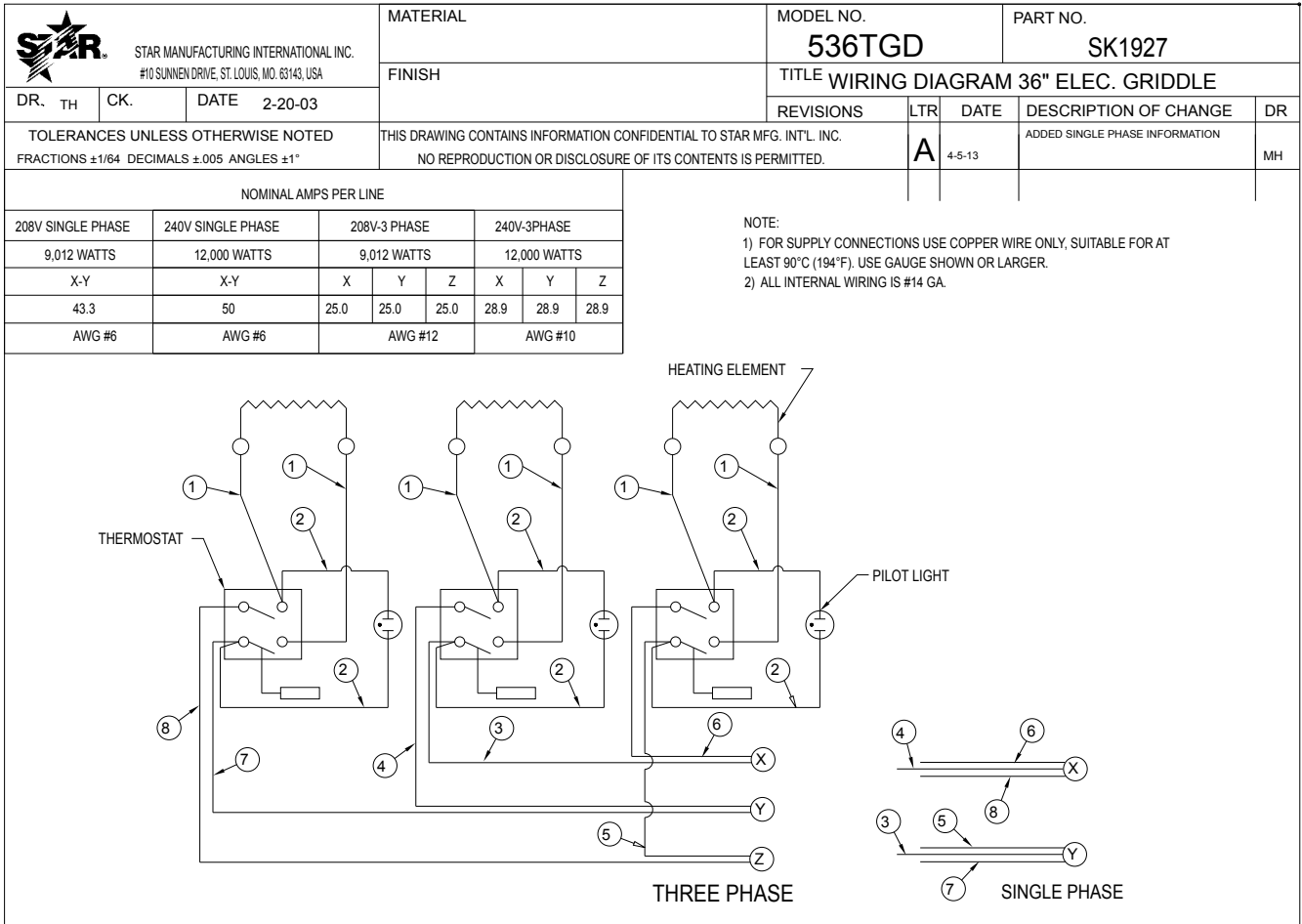

 STAR MANUFACTURING INTERNATIONAL INC. #10 SUNNEN DRIVE, ST. LOUIS, MO. 63143, USA				MATERIAL ~		MODEL NO. 536TGD 220/230V		PART NO. SK2204	
DR. TH CK. DATE 6-9-06				FINISH ~		TITLE WIRING DIAGRAM 3 PHASE 5 WIRE			
TOLERANCES UNLESS OTHERWISE NOTED FRACTIONS ±1/64 DECIMALS ±.005 ANGLES ±1°				THIS DRAWING CONTAINS INFORMATION CONFIDENTIAL TO STAR MFG. INT'L. INC. NO REPRODUCTION OR DISCLOSURE OF ITS CONTENTS IS PERMITTED.					
REVISIONS		LTR	DATE		DESCRIPTION OF CHANGE			DR	

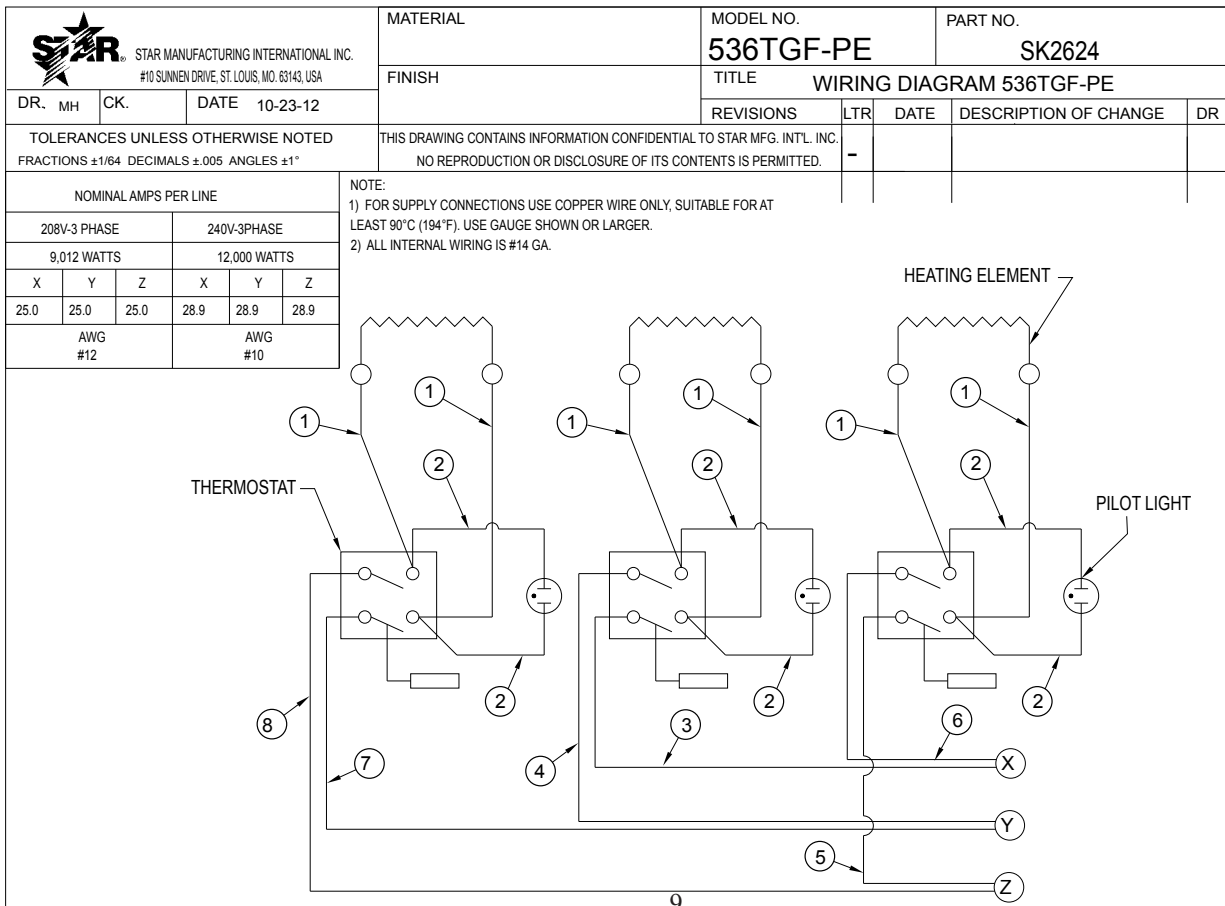
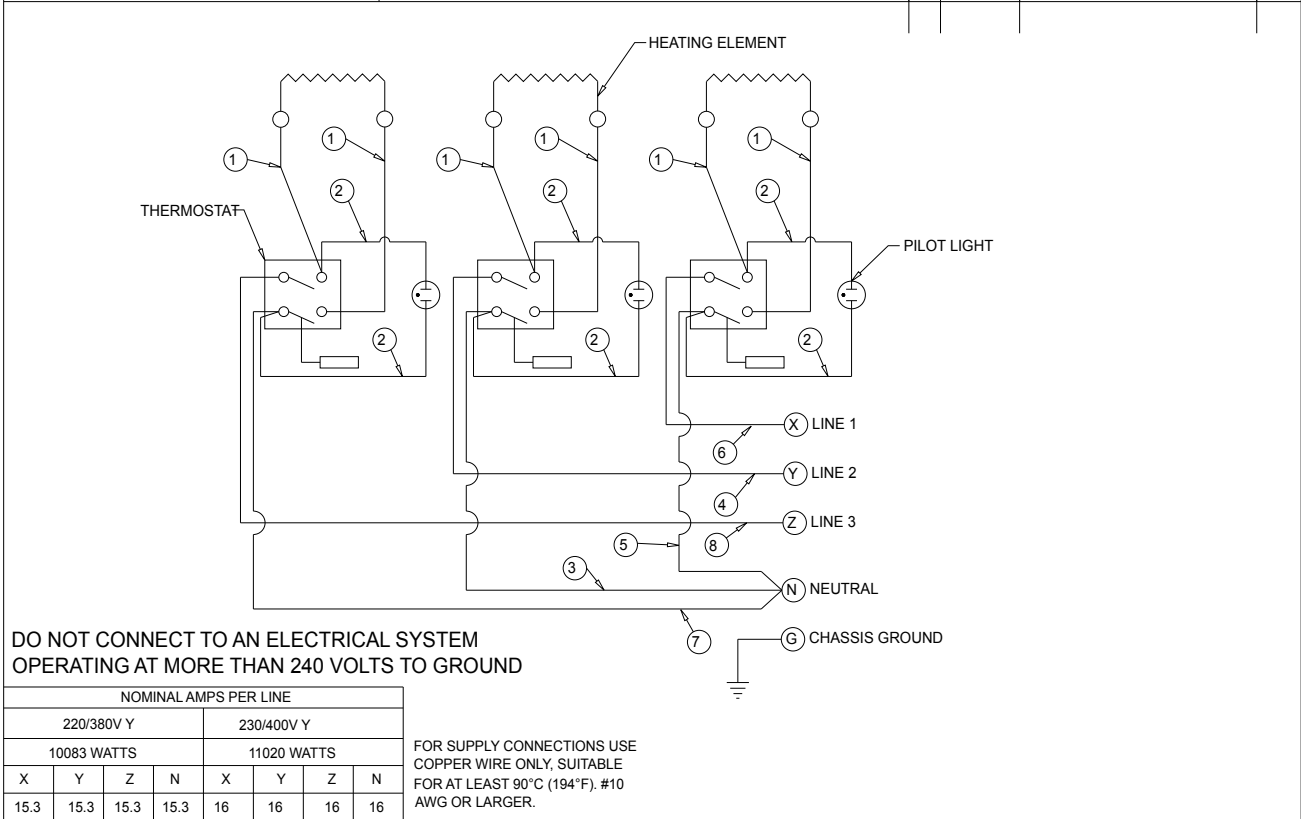

2M-Z16009 Star-Max Electric Griddle

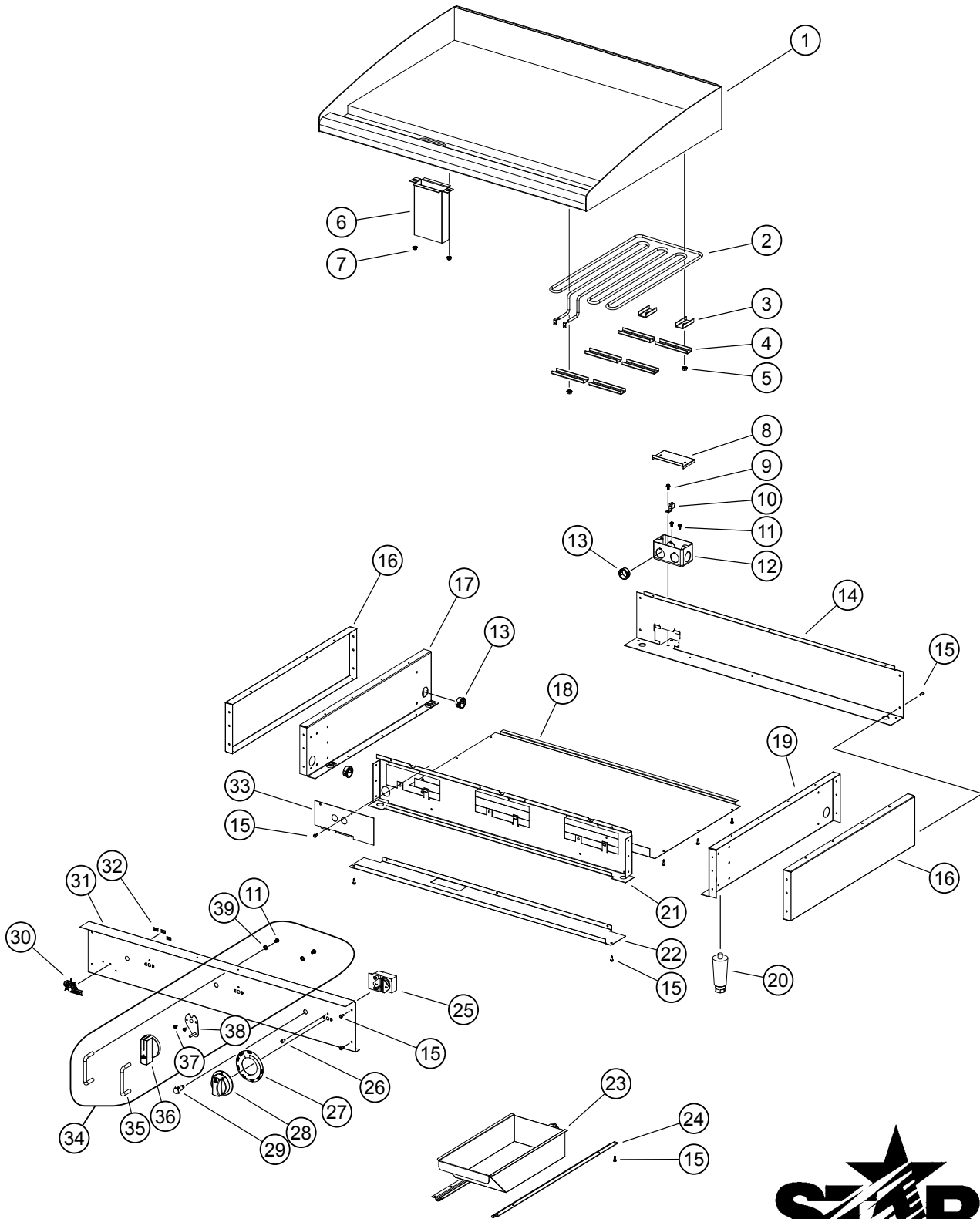

SOME ITEMS ARE INCLUDED FOR ILLUSTRATIVE PURPOSES ONLY AND IN CERTAIN INSTANCES MAY NOT BE AVAILABLE

MODEL - 524TGF, 524CHSF



STAR MANUFACTURING INTERNATIONAL, INC.

SK2597

REV. B

9/01/15

2M-Z16009 Star-Max Electric Griddle

PARTS LIST

September 1, 2015, Rev. D

Model: 515TGD, 524TGF, 536TGF and 548TGF Star-Max/Chrome-Max Electric Griddles				
Fig No	Part No.	Qty	Description	Application
1	G3-515311	1	GRIDDLE PLATE STUDDED	515TGF
	G3-524313		GRIDDLE PLATE STUDDED	524CHSF
	G3-524314		GRIDDLE PLATE STUDDED	524TGF
	G3-524315		DIVIDED PLATE ASSEMBLY	524TGF-DIV
	G3-536313		GRIDDLE PLATE STUDDED	536TGF
	G3-536315		GRIDDLE PLATE ASSY 536DIV	536TGF-DIV
	G3-536316		GRIDDLE PLATE ASSY WELDED	536TGF-PE
	G3-536314		GRIDDLE PLATE STUDDED	536CHSF
	G3-548312		GRIDDLE PLATE STUDDED	548TGF
	G3-548313		GRIDDLE PLATE STUDDED	548CHSF
2	2N-Z5948	1/2/3/4	HEATING ELEMENT	
3	G3-Z5973	2/4/6/8	ELEMENT CLAMP SHORT	
4	G3-Z16135	6/12/18/24	HEATER ELEMENT CLAMP SM	
5	2C-6517	8/16/24/32	NUT 1/4-20 HEX STL NP	
6	G3-615304	1	CHUTE ASSEMBLY	515
	G3-624304			524 / 536 / 548
7	2C-Z2893	4	NUT 10-24 HEX STL	
8	G3-Y7788	1	BOX COVER	515 / 524 / 536
		2		548
	H1-Z9843	1	CONNECTION BOX COVER	536TGF-230V
	G3-Z19326	1	COVER - CONNECTION BOX	536TGF-PE
9	2C-Y2295	1 / 2	SCREW 10X3/8 STL HEX GREEN	515, 524, 536 / 548
10	2C-Y2344	1	GROUND LUG	515 / 524 / 536
		2		548
11	2C-1512	2 / 4	SCREW 10-24X3/8 RHP STL	515, 524, 536 / 548
		14		536TGF-PE
12	2E-Y7327	1	ELECTRICAL BOX	515 / 524 / 536
		2		548
	H1-Z9842	1	SUPPLY CONNECTION BOX	536TGF-230V
	G3-Z19325	1	BOX - SUPPLY CONNECTION	536TGF-PE
13	2K-Z6183	3	BUSHING	515 / 524 / 536
		6		548
14	G3-Z5950	1	REAR PANEL	515
	G3-Z5952			524
	G3-Z5954			536
	G3-Z5956			548
	G3-Z9848			536TGF-230V
	G3-Z19324		REAR PANEL 536TGF-PE	536TGF-PE
15	2C-8833	Various	SCREW 8-18X1/2 HEX STL NP	ALL
16	G3-Z5945	2	SIDE PANEL	ALL
17	G3-624302	1	SIDE LINER ASSEMBLY LEFT	ALL
18	G3-Z5993	1	BOTTOM PANEL	515
	G3-Z5994			524
	G3-Z5995			536
	G3-Z5996			548

2M-Z16009 Star-Max Electric Griddle

**IMPORTANT: WHEN ORDERING, SPECIFY VOLTAGE OR TYPE GAS DESIRED
INCLUDE MODEL AND SERIAL NUMBER**

PAGE 1
OF 2

Some items are included for illustrative purposes only and in certain instances may not be available.



PARTS LIST

September 1, 2015, Rev. D

Model: 515TGD, 524TGF, 536TGF and 548TGF Star-Max/Chrome-Max Electric Griddles				
Fig No	Part No.	Qty	Description	Application
19	G3-624303	1	SIDE LINER ASSEMBLY RIGHT	ALL
20	2A-Z5942	4	FOOT	ALL
21	G3-Z5905	1	CENTER WALL	515
	G3-Z5915			524
	G3-Z5925			536
	G3-Z5935			548
22	G3-Z5997	1	FRONT BOTTOM PANEL	515
	G3-Z5998			524
	G3-Z5999			536
	G3-Z6001			548
23	G3-Y7046	1	GREASE DRAWER	ALL
24	G3-Z6036	2	DRAWER SLIDE	ALL
25	2T-Z5958	1/2/3/4	THERMOSTAT	ALL
26	2C-Z8547	AR	BOLT, KNOB STOP	ALL
27	2M-Z15451	1/2/3/4	LABEL ELECT T-STAT LG	515 / 524 / 536/ 548
	2M-Z18125	3	LABEL - KNOB	536TGF-PE
28	G3-624329	1/2/3/4	KNOB ASSY LG E-T KEYR	515 / 524 / 536/ 548
29	2J-Y6690	1/2/3/4	PILOT LIGHT	515 / 524 / 536 / 548
30	2M-Z15804	1	STAR-MAX LOGO	ALL
31	G3-Z15793	1	FRONT PANEL	515
	G3-Z15794			524
	G3-Z15795			536
	G3-Z15709		FRONT PANEL 5136	536TGF-230V
	G3-Z19764		FRONT PANEL w/KNOB GUARD HOLES	536TGF-PE
	G3-Z15796		FRONT PANEL	548
32	2C-8477	3	CLIP .125 PO STL PHOS	ALL
33	G3-Z5947	1/2/3/4	COVER	515 / 524 / 536 / 548
34	PS-524318		KNOB GUARD KIT	OPTIONAL ACCESSORY
35	2A-Z13272	6	KNOB GUARD	536TGF-PE
36	2R-Z8892	3	KNOB, THERM. ELEC. S-MAX, PLASTIC	536TGF-PE
37	2C-200067	6	SCREW 6-32X1/4 THP SS	536TGF-PE
38	G3-Z19058	3	KNOB STOP BRACKET	536TGF-PE
39	2C-200177	12	WASHER #10 EXT STL ZP	536TGF-PE
NI	2E-Z5969	1	WIRE SET	515
NI	2E-Z5970	1/2	WIRE SET	524 / 548
NI	2E-Z5971	1	WIRE SET	536
NI	2E-Z19258	1	CORD SET 8/4 50 AMP LOCK	536TGF-PE

STAR MANUFACTURING INTERNATIONAL INC.

Star - Holman - Lang - Wells - Toastmaster
 265 HOBSON ST. SMITHVILLE, TN 37166
 (800) 264-7827
 www.star-mfg.com